



INSTALL ATION M A N U A L



GREENLAM INDUSTRIES LIMITED
2nd Floor, West Wing, Worldmark I, Aerocity IGI Airport Hospitality District,
New Delhi - 110037. Tel: (91 11-4279-1399). Email: info@greenlam.com
www.greenlamindustries.com

GREENLAM EXPERIENCE CENTER
25/B, Shop No. E & F, Mirza Ghalib Road, Park Street, Opposite Westside Mall,
Kolkata - 700016.
Contact No.: - +91 33 4601 7151; +91 9836007771; +91 6292263309
E-mail: experiencecenter.kolkata@greenlam.com



CLADS
EXTERIOR GRADE COMPACT LAMINATES

STB INNOVATIVE CONSTRUCTION

09-8659011 | info@stboards.com | www.stboards.com

C O N T E N T S

About Clads	01
Features	02
Quality Assurance	03
Product Construct	04
Superior Technology	05
Product Specifications	06
Ventilated Facade System	07
Installation Methods	08
Installation Guidelines	09
Working Recommendation	10
Various Areas of Application	11
Technical Specifications	12

9116 - EDEN OAK

Application images are for illustration purposes only. Please refer to the actual product samples for colours and finishes available.

STB INNOVATIVE CONSTRUCTION

09-8659011 | info@stboards.com | www.stboards.com

9118 - MORGAN OAK



CLADS
EXTERIOR GRADE COMPACT LAMINATES

SOLUTION FOR EXTERIORS

Make heads turn with the incredibly stunning Greenlam Clads. A perfect solution for exterior wall cladding, Clads is a premium range of exterior-grade compacts that elevates the decor of your building. It takes the spotlight not only for its magnificent looks but also for its exceptional functionality. Like its unmatched GLE Technology that makes it strong enough to retard fire, extreme weather conditions, and even bacteria. Coupled with its 12-year warranty, Clads is an excellent choice for exterior cladding that lasts decades.

STB INNOVATIVE CONSTRUCTION

09-8659011 | info@stboards.com | www.stboards.com

9117 - SUNBURN OAK

UNMATCHED

FEATURES



12 YEARS WARRANTY



FIRE RESISTANT



EXCELLENT ANTI-GRAFFITI PROPERTIES



CHEMICAL RESISTANT



ENERGY EFFICIENT



MATCHING RIVETS



ANTI-DUST



MOISTURE RESISTANT



ENVIRONMENT FRIENDLY



LOW VOC EMISSION



RESISTANCE TO ACID RAINS



CORROSION RESISTANT



TERMITE RESISTANT



ANTI-BACTERIAL AND ANTI-FUNGAL



ACOUSTIC RESISTANCE



GLE TECHNOLOGY



CAN WITHSTAND EXTREME TEMPERATURE CONDITIONS FROM -60°C TO +80°C



SUPERIOR LIGHT FASTNESS PERFORMANCE (UV RESISTANCE)

STANDARD SIZE: 4.25' x 10' | 1300mm x 3050mm
STANDARD THICKNESS: 6mm | 8mm | 10mm
TEXTURE: Suede

STB INNOVATIVE CONSTRUCTION

09-8659011 | info@stboards.com | www.stboards.com

QUALITY ASSURANCE



*To know more on test reports please visit www.greenlambob.com



PRODUCT CONSTRUCT

INTERNAL STRUCTURAL DETAILS

Greenlam CLADS are self-supporting high pressure laminates (HPL) with a decorative surface that is suitable for exteriors. It is fade-resistant, weather-proof, and compliant to the standards of EDF (EN 438 - 6 Exterior Grade Severe Use Flame Retardant) which is the best in this classification.

The polymeric resins used are made with Non-Halogenated Fire Retardant chemicals which make the HPL fire-retardant.

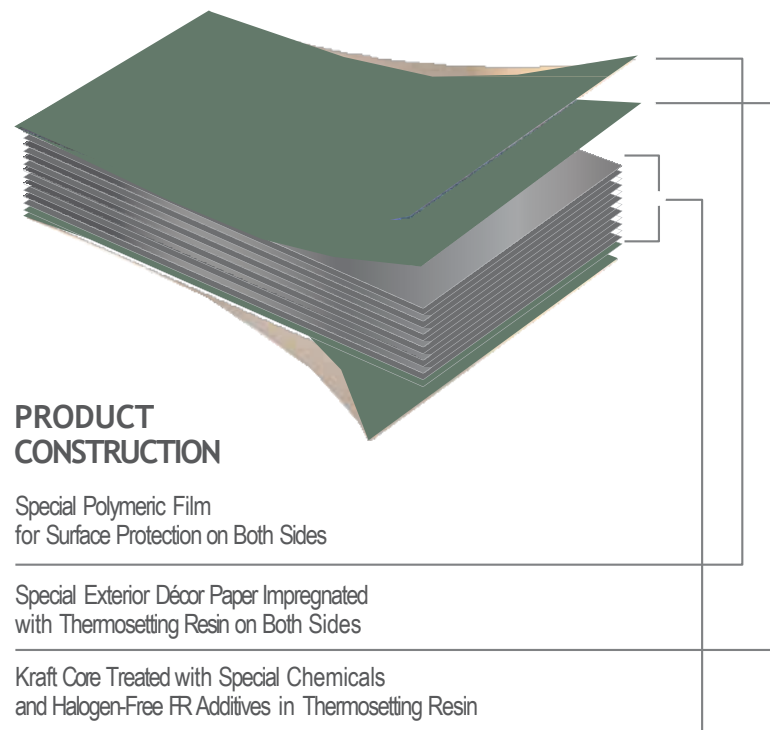

THE PRODUCT IS MADE UP OF:

- 1) Layers of kraft paper impregnated with halogen-free FR-Grade phenolic resins that make the product fire-retardant.
- 2) Both the sides have a special exterior-grade decorative paper surface made using extreme light stable pigments, special chemicals, and inks that are then impregnated with melamine resins. The decor paper is rated 3-5 on Grey Scale, hence making it fit to use for exteriors.
- 3) Best quality polymeric surface protection film layer on the front and rear surface of the board. This film layer guards the surface of Greenlam Clads when exposed to the combined action of direct sunlight, rains/acid rains, hail, wind, frost, exhaust fumes, graffiti, and corrosion/salt deposition.

SUPERIOR TECHNOLOGY

THE SUPERIOR GLE TECHNOLOGY

The GLE Technology from Greenlam R&D team makes Greenlam CLADS a sturdy product that can withstand extreme weather conditions and makes it perfect for exterior use. This technology/process of making the product is based on three main pillars:



**SUPERIOR
MANUFACTURING
TECHNOLOGY**



**DÉCOR PAPER
WITH STRONGER
LIGHTFASTNESS**



**BEST QUALITY
POLYMERIC SURFACE
PROTECTIVE FILM**

Superior Manufacturing Process	Special Décor Paper	Special Protective Film
<ul style="list-style-type: none"> - High Bonding Strength - Mechanically Sturdy - No Splintering - Easy Machinability - Excellent Fire-Retarding Properties - High Dimensional Stability - High Impact Resistance - High Flexural Resistance 	<ul style="list-style-type: none"> - Use of High Quality Exterior Grade Décor/Design Paper made using extreme light stable pigments, special chemicals, and inks. - The décor paper rates 3-5 on Grey Scale, hence it is suitable for exterior applications. - Décor Papers are free from Leads, Arsenic, and Cadmium. 	<ul style="list-style-type: none"> - Excellent UV Performance - Extreme Weather Stability - Excellent Chemical Resistance - High Anti-Dust Properties - Scratch Resistant - Corrosion Resistant - Frost Resistant - Excellent Anti-Graffiti Properties - Resistance to Acid Rains - Easy to Clean of surface

STB INNOVATIVE CONSTRUCTION

09-8659011 | info@stboards.com | www.stboards.com

PRODUCT SPECIFICATIONS

VENTILATED FACADE SYSTEM

GREENLAM CLADS – WEIGHT INFORMATION			
THICKNESS	WIDTH	LENGTH	WEIGHT
6 mm	4.25 ft / 1300mm	10 ft / 3050mm	34±1Kgs
8 mm	4.25 ft / 1300mm	10 ft / 3050mm	45±1Kgs
10 mm	4.25 ft / 1300mm	10 ft / 3050mm	56±1Kgs

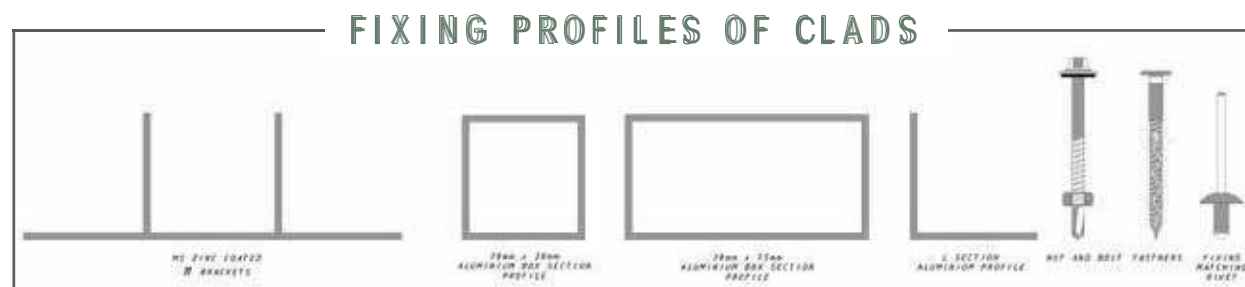
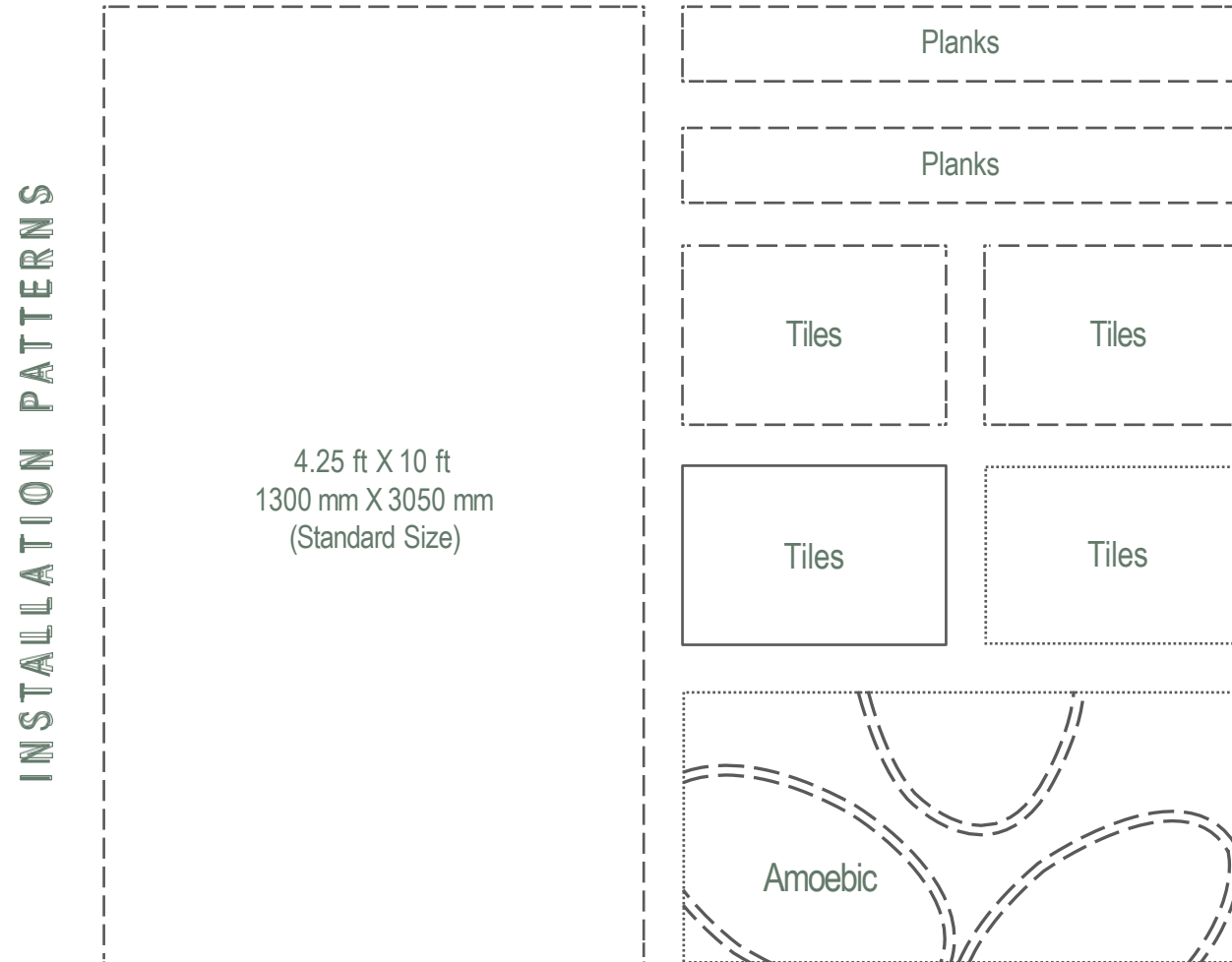

Aesthetics aside, the technical purpose of ventilated facades is to protect the structure from weather and environmental conditions while providing effective thermal insulation. Greenlam CLADS® is proven to meet these challenges over a long working life, without demanding maintenance schedules. Forming elevations from Greenlam CLADS®, you have the ability to insulate to the defined specification by selecting panels from a range of thicknesses, and create buildings with the desired levels of energy efficiency and CO2 emissions. Winter heat retention can be maximised with Greenlam CLADS®, as can temperature control in summer or in high ambient heat locations. Ventilating facades made using Greenlam Clads can optimise the combined performance of the structure and facade, protecting against moisture accumulation while delivering thermal and acoustic insulation. The performance and installation parameters of the project should always be discussed with the Greenlam Clads team as part of the specification process, and the fixing system providers should also be involved at this stage. The relevant static calculations for the elevations must be completed. All subsequent installation operations should be performed by appropriately trained personnel.

A: PANEL JOINING

The joining solution favoured in most projects incorporates expansion gaps of 6 mm minimum. All fixings must be moisture- and corrosion-resistant, and gaps should be wind-proofed from the inside of the cavity. If the panels used are of 8 mm thickness or more, they can be connected by tongue and groove joints with the horizontal joints overlapped for a closed arrangement, as shown below.

B: RULES OF INSTALLATION FOR ELEVATION PANELS

Installation of the panels should be carried out only by qualified professionals. The panels can be fixed to the bearing structure using rivets, bolts/elevation screws, adhesive systems, or staples fixed to the rear side (invisible mechanical fixing). All joints of the panels with other elements and the substrate should be made in a firm manner.

C: SOLUTIONS FOR CORNERS

Selecting the best method for corner-forming is dependent on the thickness of the panel used. We recommend a thickness of 8 mm or more, because this allows enough material depth to enable correct screw setting or the machining of the groove for the tongue (the tongue should be 3 mm thick). The number of fixings and the distance between them will depend on the spacing of the substructure.

INSTALLATION METHODS

The Greenlam CLADS panels behave like wood in changing weather conditions — they expand when absorbing moisture and contract in dry air discharging moisture. Taking these properties into consideration during installation, the appropriate compensation clearance should be applied (the expansion gaps between panels should be 8-10mm), assuring a possibility of uniform expansion of panels. To this end, one fixed point should be made. The other fixing points can be made as non-fixed points.

Method 1: With Rivets

A: Installation done with rivets on an Aluminium Box section Substructure (Practiced in Asian Countries)

Greenlam CLADS panels of 6mm, 8mm, and 10mm are suitable for the riveted system on an aluminium substructure. This system is applied to high-rise buildings.

Substructure

The aluminium substructure has to conform to regional stroke standards and has to be installed in accordance with the manufacturer's specifications for the substructure. The aluminium substructure basically consists of vertical support profiles which are mounted on the wall using pie brackets. Due to the material properties of Greenlam CLADS panels, fixed points and sliding points need to be made in order to fix the panels.

The dimensions of CLADS, however, alter under the influence of changing relative humidity. When installing, attention must be paid to the expansion clearance. Thumb rule for calculating the required expansion clearance is:

$$\frac{X \text{ or } Y \text{ (in mm)}}{500} = \text{Expansion Clearance}$$

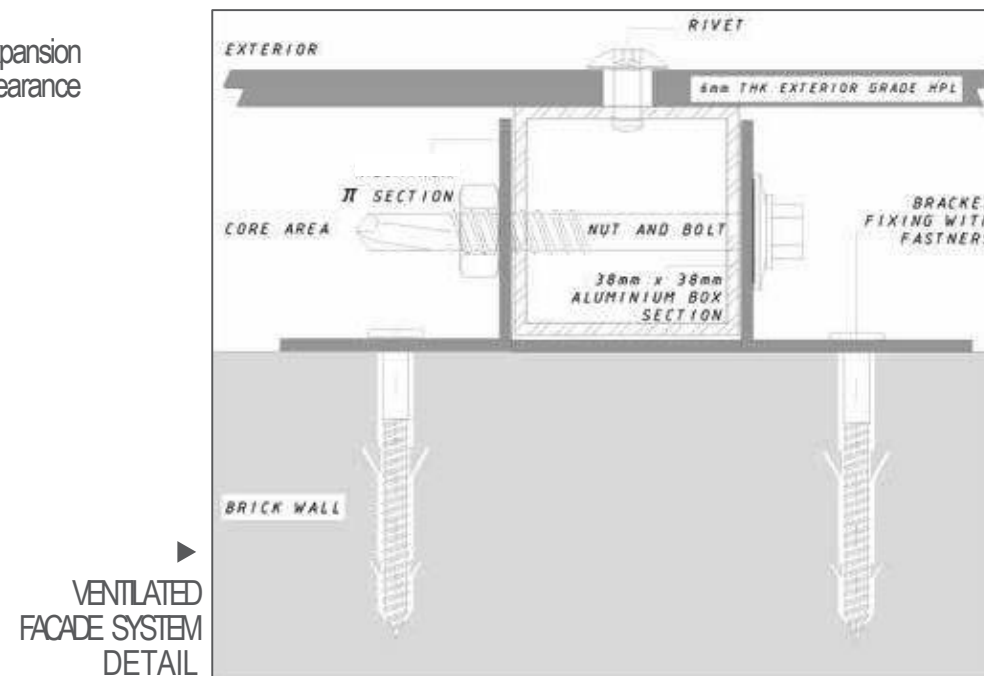

INSTALLATION METHODS

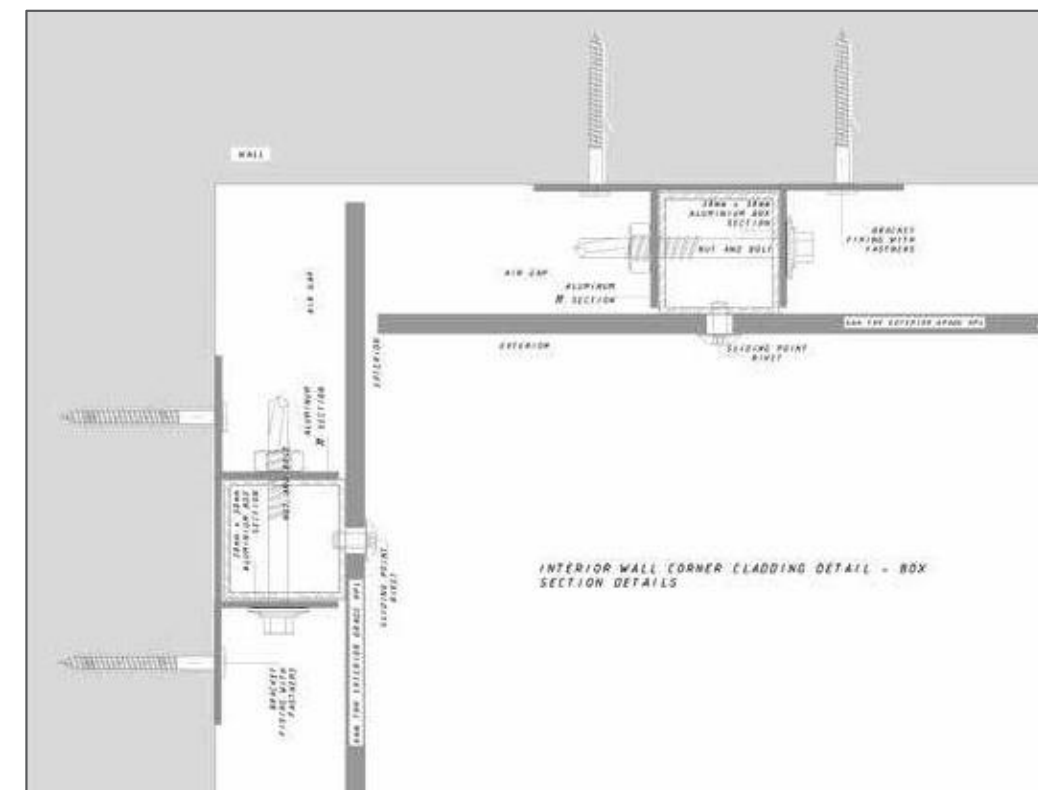
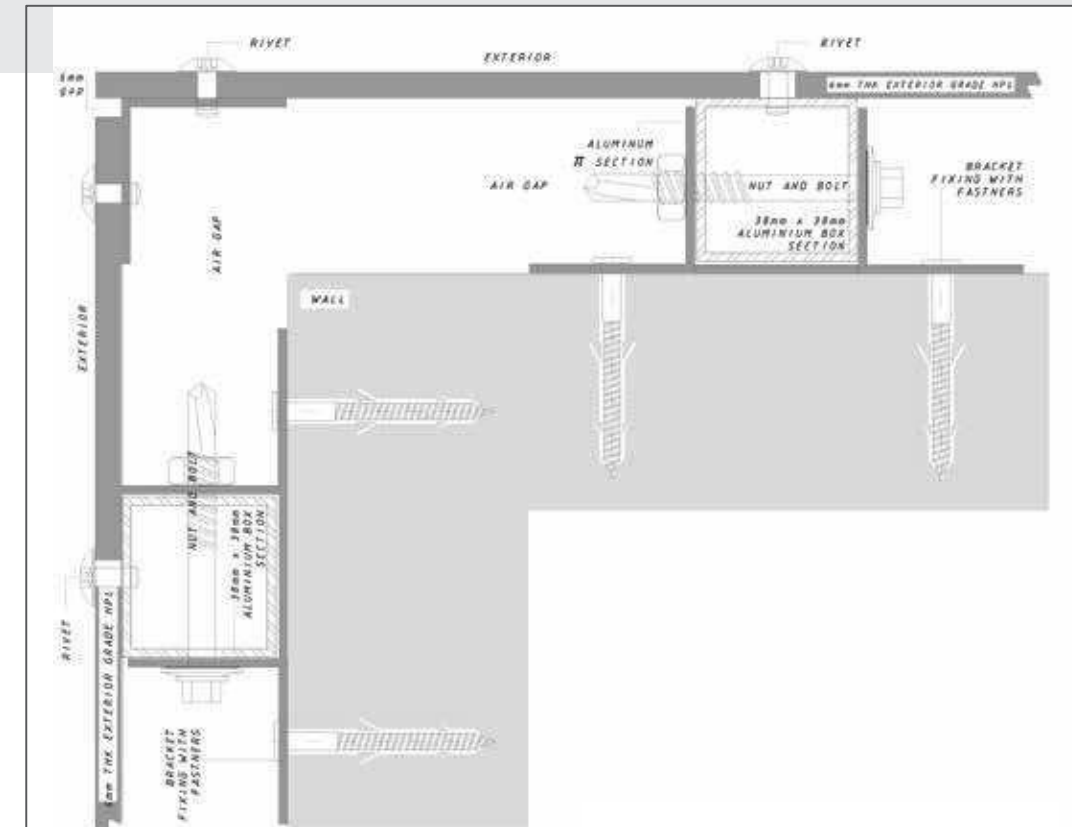

INSTALLATION METHODS

B: Installation done with rivets on an Aluminium LT Section Substructure (Practiced in Other Countries)

Greenlam CLADS panels of 6mm, 8mm, and 10mm are suitable for the riveted system on an aluminium substructure. This system is applied to high-rise buildings.

Substructure

The aluminium substructure has to conform to regional stroke standards and has to be installed in accordance with the manufacturer's specifications for the substructure. The aluminium substructure basically consists of vertical support profiles which are mounted on the wall using angle brackets. Due to the material properties of Greenlam CLADS panels, fixed points and sliding points need to be made in order to fix the panels.

The dimensions of CLADS, however, alter under the influence of changing relative humidity. When installing, attention must be paid to the expansion clearance. Thumb rule for calculating the required expansion clearance is:

$$\frac{X \text{ or } Y \text{ (in mm)}}{500} = \text{Expansion Clearance}$$

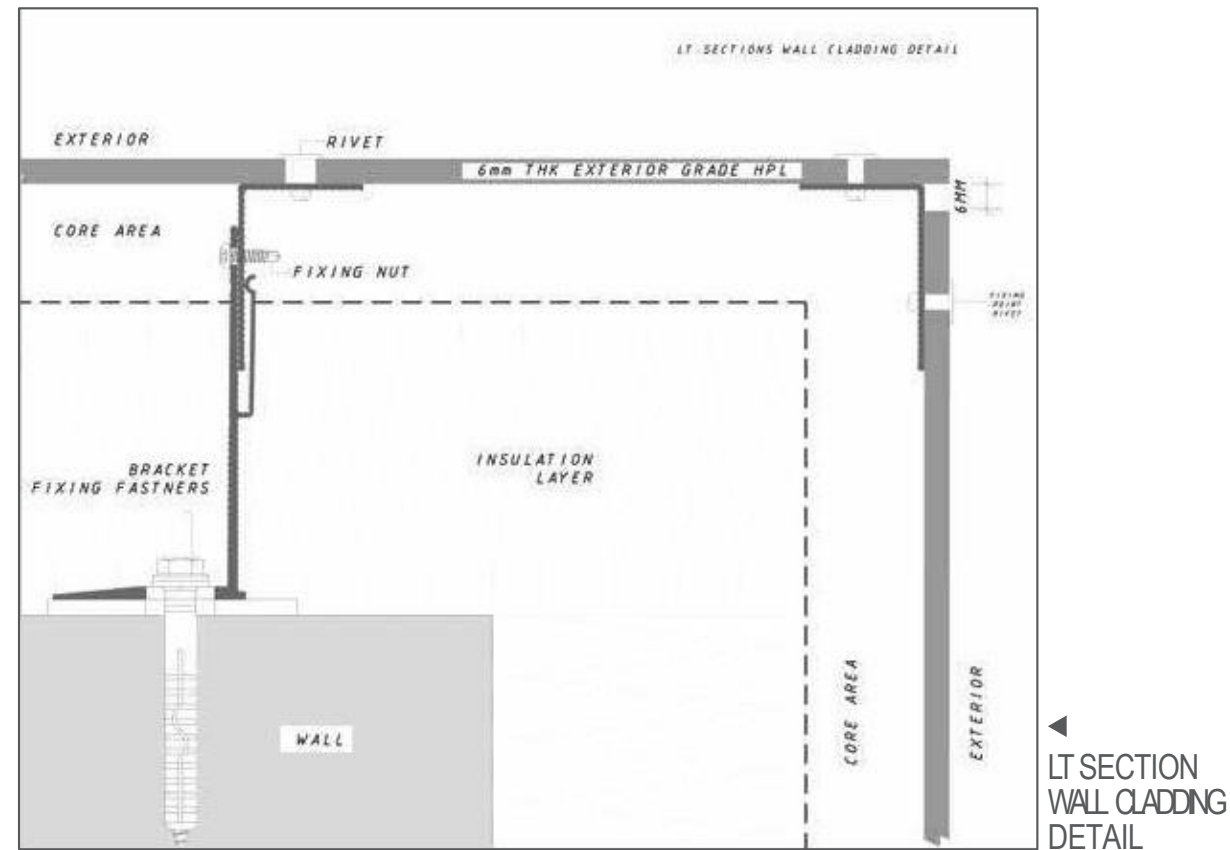

INSTALLATION METHODS

Method 2: Fastening with the Glue System (Without Rivets) Application applicable up to 10m meter height only

An alternative to visible mechanical fixing with rivets is gluing the GREENLAM CLADS facade panels with gluing systems specially developed for this purpose. It works on normal planed aluminium sub-constructions. Gluing is a clean and simple solution for rear-ventilated facades, attics, visible roof under faces, reveals, etc.

As a prerequisite, permission must be sought from the authorised building officials of the region/country.

Following are the products that are used to bond high pressure laminates using the Panel Lock system.

- DOW Coming 896 Sealants or Equivalent
- 3M™ VHB™ G23F Structural Glazing Tape or Equivalent (Tape Thickness 6mm, As Per Panel Size and Design)
- 3M PU Primer OS1200 or Equivalent

Both the sealant and VHB tapes are very durable and are resistant to UV radiation. While the VHB tape gives immediate holding strength and ensures consistent sealant bead thickness, the 540 PU sealant provides the additional anchorage against possible cleavage stresses on the edges due to wind load.

(Effective at temperatures below 35°C, humidity should be 55%±5%, and the atmosphere should be dust-free.)

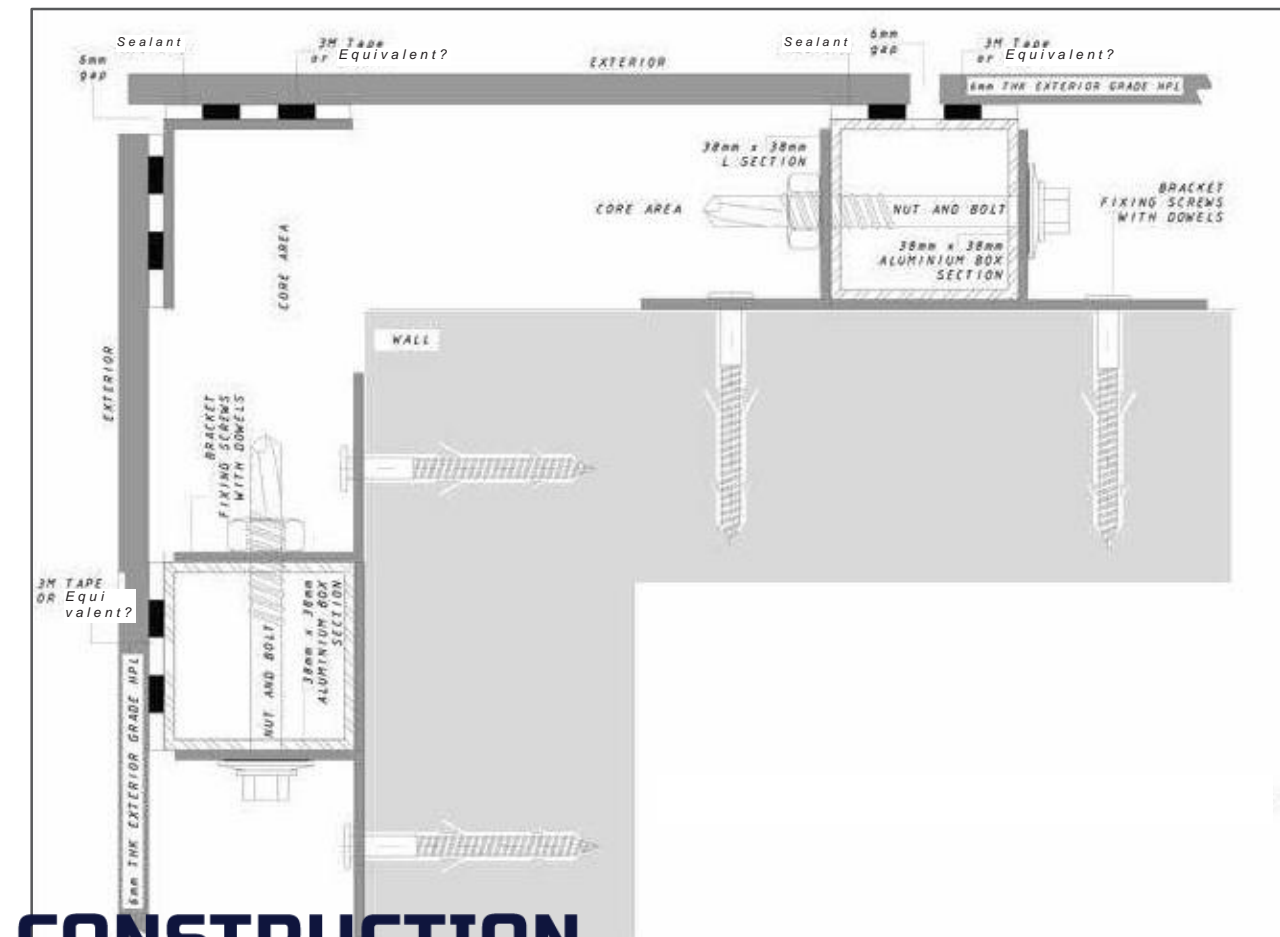

INSTALLATION METHODS

Working sequence for installing Greenlam CLADS using secret glued fastening system:

Following are the steps in general, to be followed for getting the optimum results.

- Aluminium Substructure Creation
- Surface Preparation & Priming
- VHB & Sealant Application
- Panel Cladding

INSTALLATION GUIDELINES

GREENLAM CLADS INSTALLATION GUIDELINES

A: SURFACE PREPARATION & PRIMING

- **Abrasion:** The bonding area on both the metal frame surface and backside of the Greenlam CLADS are abraded using a Scotch Brite pad/fine emery paper. Do not use a coarse abrasive product, use emery paper finer than #220 grit. Abrasion will remove any scales/oxide/LSE coating, and will also improve adhesion by creating very fine scratches.
- **Surface Cleaning:** The surface is cleaned of dust after the abrasion first with a dry cloth and then with OS1200 cleaner or equivalent. Do the cleaning by wiping a single direction and allow the solvent to evaporate.
- **Priming:** To promote the adhesion and for a durable bond the surface needs to be primed – with OS1200 or equivalent. The primer can be applied either with a brush or with a swab, to get a uniform coating on the surface. The primer should be continuous with a single wipe in one direction. Soak the swab with enough primer to achieve this in one stroke, it is not recommended to reverse the direction of the swab while applying primer. The primer should be applied only on the bonding areas and allowed to dry. The surface preparation of the Greenlam CLADS panel is done just before bonding but before sealant application on the frame. The bonding should be completed at the earliest to avoid any dust accumulation on the surface.

B: VHB TAPES & SEALANT APPLICATION

- **VHB Application:** It is advised to apply VHB Tape before opening the sealant pack, as extended exposure of sealant bead will cause skin formation. Unwind a sufficient length of VHB tape from the roll, hold the edge of the tape, and leave the portion where it is touched by the fingers outside. Press the tape end to the frame, align the tape to the outer edge of the frame, and press the tape down from one edge to the other. It is recommended to use 3M HTA or equivalent for bubble-free application of the tape. Give an overlap wherever the tape needs to be joined, and then cut the overlapping edges of the tape to get a neat butt-joint. Press the tape with squeegee or rubber roller to ensure proper surface contact and to initiate the flow.

INSTALLATION GUIDELINES

- **Sealant Application:** It is recommended to apply the sealant as a triangular bead of 6-8 mm base and height approx. 10-12 mm away from the tape. The nozzle of the sealant sausage/cartridge is cut at proper length with a “V” notch to get the triangular bead with the dimensions mentioned. The sealant application and cladding should be completed within the skin formation time of the sealant, restrict the area of application in one go accordingly. Apply sealant as a continuous bead with uniform dimensions. The triangular shape of the bead will help to get the maximum contact area between the sealant and panel when squeezed and to get a near rectangular bead.

C: PANEL CLADDING

Remove the liner from the tape, place the panel to be bonded over the tape, and sealant bead, without pressing. At this point, the panel can be moved to get a proper alignment, as it is not touched on the tape surface. Make sure that there is not much movement while aligning, once the panel touches the sealant bead, to avoid any contamination the tape bonding surface with sealant. Once the alignment is properly done, push the panel to lock it in place and then press down with a rubber roller or by hand pressure. Bond strength is dependent upon the amount of adhesive-to-surface contact developed. Enough pressure should be applied so that both surfaces fully contact the tape, the bond strength will increase as the adhesive flows onto the surface.

Please note using the gluing system for installing Greenlam CLADS panels needs optimum curing time so as to attain the best possible bonding for or VHB tape, at room temperature between the aluminium substructure and compact laminate panels.

- 50% of the ultimate strength in 20 minutes
- 90% after 24 Hrs.
- 100% strength is attained after 72 Hrs.

The sealant cure rate depends on the temperature and humidity and is mentioned in the technical data sheet.

INSTALLATION GUIDELINES

FOR GLUED INSTALLATION (SPACING OF THE VERTICAL SUPPORT CONSTRUCTION)		
Panel Thickness	Maximum Fastening Spacing Single Span Panel	Maximum Fastening Spacing Double Span Panel
6 mm	350 mm	400 mm
8 - 10 mm	350 mm	400 mm

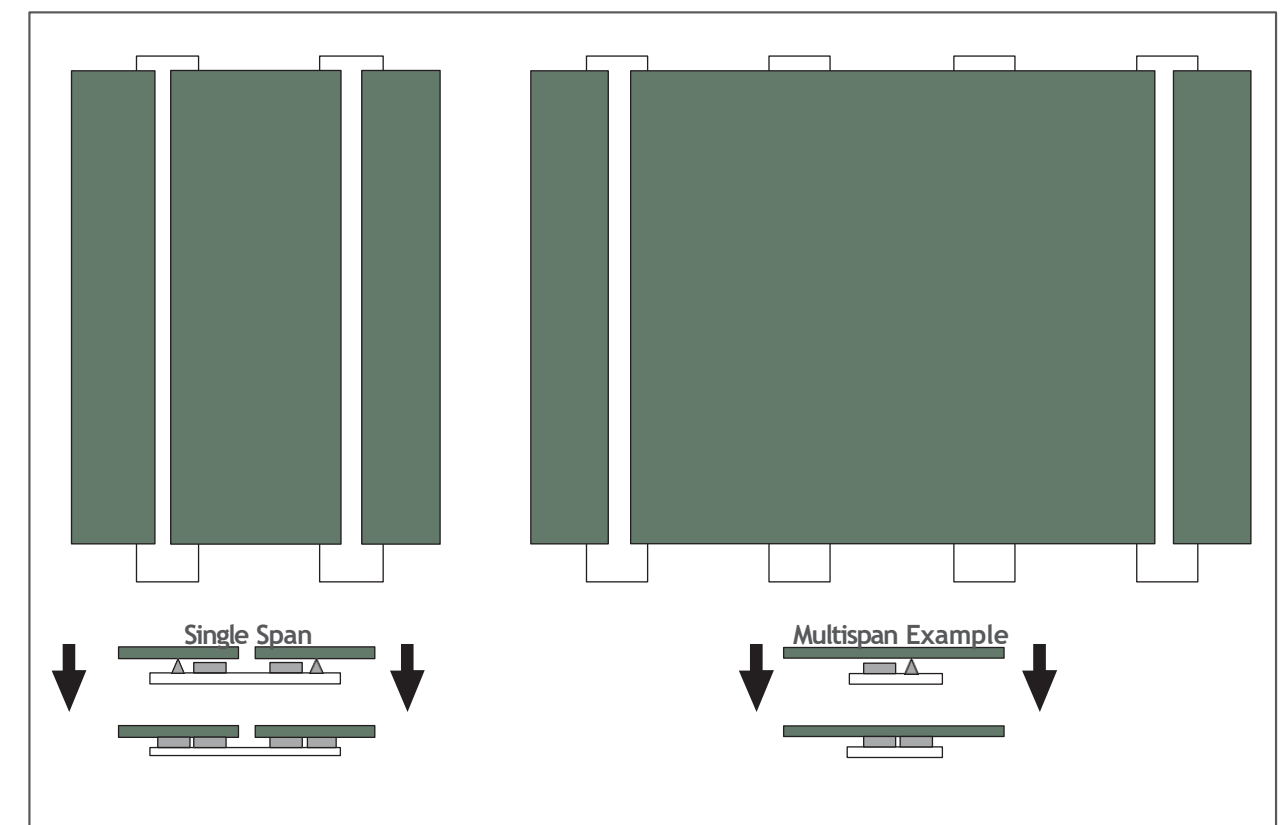

Important Points to Remember:

- Surface preparation is a basic requirement to ensure proper adhesive contact to the base surface.
- VHB won't allow any air to pass through it. Apply it without air bubbles.
- Don't use VHB/sealant bead in pieces but use in continuous length.
- Complete the bonding before the skin formation happens on the sealant bead.
- Pressing down the tape is necessary to initiate flow and to ensure proper surface contact.
- Follow the safety instructions & handling precautions given in the respective datasheets/MSDS, while handling solvents and primer

INSTALLATION GUIDELINES

FIXED POINTS

Fixed points are used for the uniform distribution of the expansion and shrinkage movements. The diameter of the drill hole in Greenlam CLADS must measure 5.1 mm.

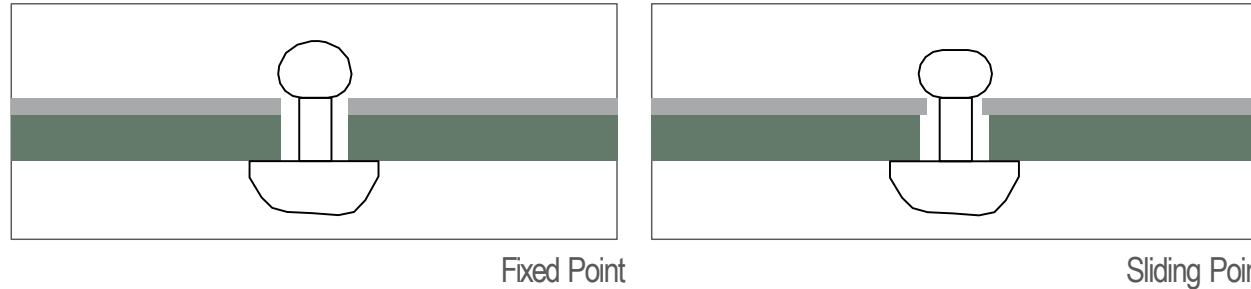

SLIDING POINTS

The diameter of the drill hole in Greenlam CLADS must be drilled larger than the diameter of the fastening, depending on the required expansion clearance. This is the shaft diameter of the fastening plus 2 mm for every meter of cladding material starting from the fixed point. The head of the fastening must be big enough so that the drill hole in Greenlam CLADS is always covered. The fastening is placed in such a way that the panel can move. Rivets are put in place with flexible mouthpieces. The defined clearance of the rivet head to the surface of the panel (0.3 mm) allows movement of the element in the drill hole. The center point of the drill hole in the sub-construction must coincide with the center point of the drill hole in the Greenlam CLADS panels. Drill with a centering piece. The fastenings should be put in place starting from the middle of the panel outwards.

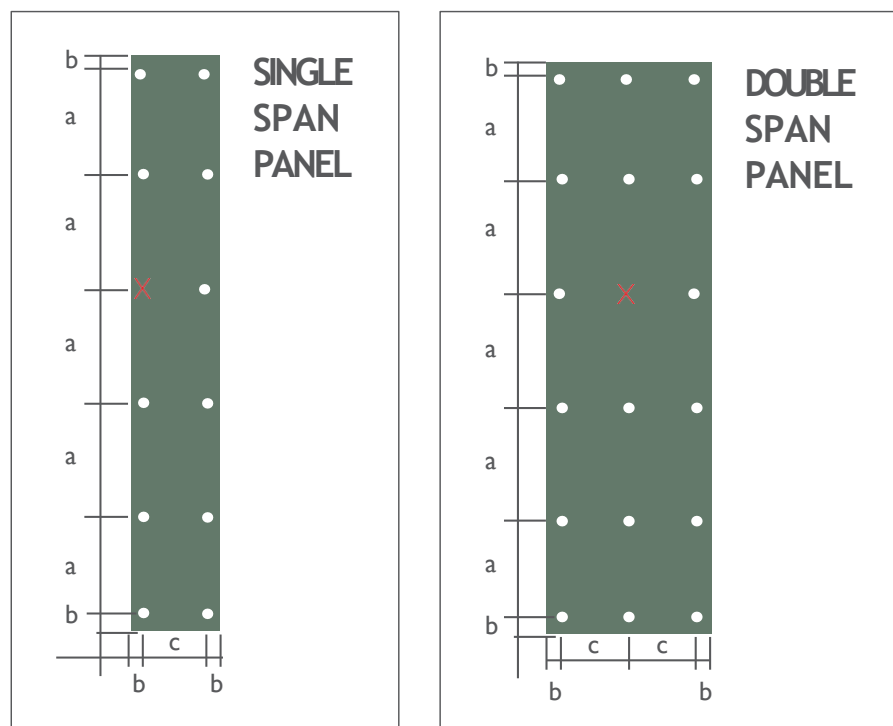

X Fixed Point
 O Single Point

INSTALLATION GUIDELINES

GREENLAM CLADS - MECHANICAL FASTENING INSTALLATION (SINGLE SPAN PANEL)			
Thickness	Maximum Distance between Holes from Edges (b)	Maximum Distance between Holes in width (c)	Maximum Distance between Holes in length (a)
6 mm	25-50 mm	400 mm	450 mm
8 mm	25-50 mm	550 mm	650 mm
10 mm	25-50 mm	650 mm	850 mm

Edge Spacing

For reasons of stability and flatness, the edges gap must be kept in consideration, without fail. The joints must be made at least 8 mm wide so that changes in size can take place without any hindrance.

Fastening Spacing

These are to be chosen in accordance with the structural engineering requirements (calculations), or if this is not necessarily due to the local regulations. In the edge region of the construction, the spacing of the fastenings is to be kept smaller than the spacing in the central region (pressure, suction).

Fastenings

We recommend using only fastening (riveting) which is specially developed for Greenlam CLADS. These rivets are made available along with the product.

Rivet Body: Aluminium Alloy 5051

Rivet Pin: 302 AISI

Pull-off strength of rivet pin:

Min. 4626N & Max. 5382N

Diameter of the drill hole in Greenlam CLADS panels:

- Sliding points: 8.5 mm or as required
- Fixed points: 5.1 mm
- Diameter of the drill hole in the aluminium substructure: 5.1 mm

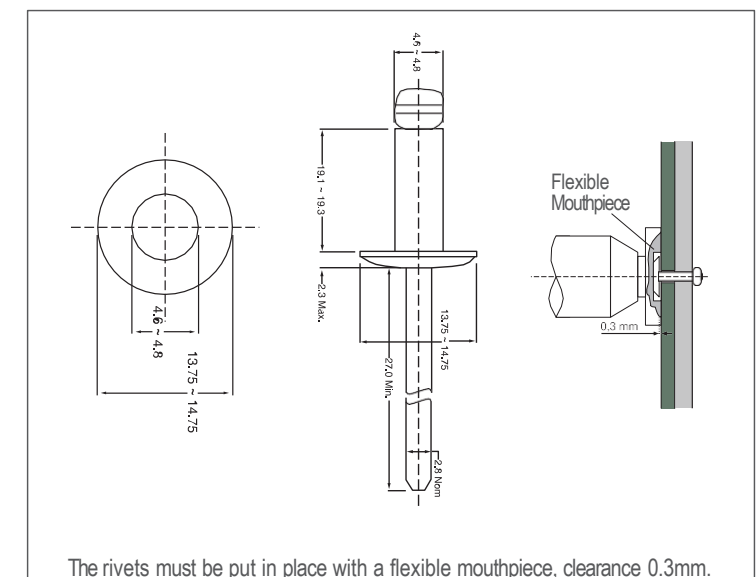

WORKING RECOMMENDATION

1 - CLEANING AND MAINTENANCE

It's very easy to maintain Greenlam CLADS panels – most dirt can be removed simply by wiping with a dampened cloth or sponge. More stubborn staining can be handled with a suitable household detergent. The UV-resistant panels may be cleaned with alcohol based cleaners, but it's always good practice to test-clean an unobtrusive area before undertaking complete cleaning. Products containing abrasives are not recommended for use with Greenlam CLADS®. Pressure washing presents no problems, the jet should be directed from the bottom to top of each panel then laterally at a distance of 20-30 cm, finishing with a rinse of clean water. Jet wash pressure should not exceed 100 bar and water temperature should be no higher than 90-100°C.

This is most easily done as follows: for cleaning purposes, use unsoiled, warm water, clean cloth or rags, and soap (housework-related cleaners which are sold in shops). Avoid scouring substances.

Although the adhesion of inks/paints is very low on the Greenlam CLADS Panels, we recommend, not to clean the surface dry or by using any tools. The risk of damaging the top special polymeric surface is too high. Alternatively, solvent cleaners could be used for removing varnishes, paint sprays (graffiti), and other similar stains and marks.

2 - TRANSPORT AND HANDLING

Once installed, Greenlam CLADS panels offer exceptional durability, but in storage and handling surfaces and edges can be damaged if handled without care. The panels are supplied with foil protection covering, but it's recommended that when stacking dust and larger particles should be removed from between the panels. Panels should be stacked with thicker ones at the bottom, lighter panels towards the top, and care should be taken not to overload the stack. The panels should be secured against slipping against each other in transit and handling, and the protective foil should not be exposed to continual direct sun or heat.

Points to remember

- Greenlam CLADS must be secured against slippage during transport.
- When loading or unloading, the panels must be lifted not dragged.
- Do not push or pull them over the edge.

Handle Greenlam CLADS with care in order to not damage the edges of surfaces. Despite the excellent surface hardness and the installation protection film, the stack weight of Greenlam CLADS can cause a possible damage.

Installation protection films must always be removed from both the surfaces immediately after the installation.

WORKING RECOMMENDATION

TRANSPORTATION AND HANDLING INSTRUCTIONS

DOs	DON'Ts
Ensure storage of Greenlam CLADS in dry, clean, frost-free and enclosed warehouses where normal interior conditions (18°C - 30°C and 50% - 65% relative humidity) are maintained.	Don't stack the pallets in open yards, expose the stacks to sunlight and rainfall directly till they are fabricated and installed.
Cover the top board of each stack with a moisture barrier/cover board with sufficient weight to remain flat and in contact with the whole surface area of the top.	Don't allow Greenlam Compact panels or panels to rest on moisture absorbing supports like paper, cloth, or gunny bags. The base board must be dry, and should ideally be covered with a material impervious to water, to act as a moisture barrier.
The pallets or Compact panels or cut panels must be stored on a rigid and levelled surface that ensures support all across the full surface area of the panels or panels as the case may be.	Don't keep the panels or cut panels in a leaning position against walls, supports, or board stacks. This would cause the panels or panels to warp.
Greenlam CLADS will remain flat when stored horizontally in packs on a flat base board with their edges flush with one another.	Failure to store Greenlam CLADS flat for any length of time can cause deformation which is almost impossible to rectify.
Allow time for the stack of the Compact panels or the cut panels for conditioning at the fabrication site and allow them to reach equilibrium with the environment.	Don't attempt to fix the panels immediately after cutting and routing. This can lead to warp or twist. Allow them to condition in the environment for few hours.
<p>Peel coat:</p> <ul style="list-style-type: none"> - Try and keep the protection peel coat film till the installation is complete to avoid scratches, surface stains, dust, etc. - In case it is required to remove the protection peel coat film, please ensure that the film applied on both sides is removed at the same time. 	<p>Peel coat:</p> <p>Never keep one side's film intact and remove the film from the other surface. This causes imbalance in the panel and can lead to warp.</p>

WORKING RECOMMENDATION

3 - STORAGE AND CONDITIONING

Greenlam CLADS panels must be stacked horizontally on flat, stable supports and supporting panels. The goods must lie completely flat. After removal of panels, PE films must again be closed over the stack. The same applies, in principle, for cut-panel stacks.

Incorrect storage can lead to permanent deformation of the panels. CLADS panels are to be stored in closed rooms under normal climatic conditions, duly wrapped with PE film. Climate differences on the two surfaces of a panel are to be avoided.

- Stacking of Greenlam CLADS panels should be done up to 250mm in height (numbers may vary depending on the thickness of the panel)
- Stacking should be done on a raised sturdy platform.
- Ensure covering film after pulling out the required number of sheets systematically.

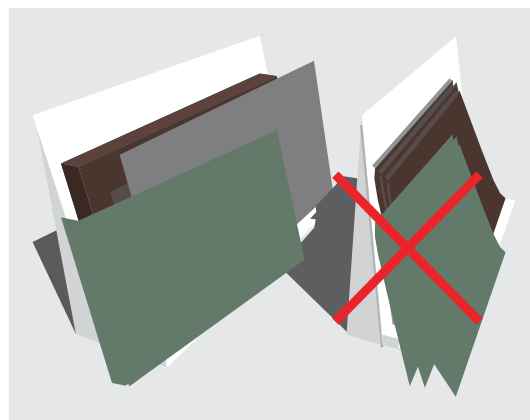
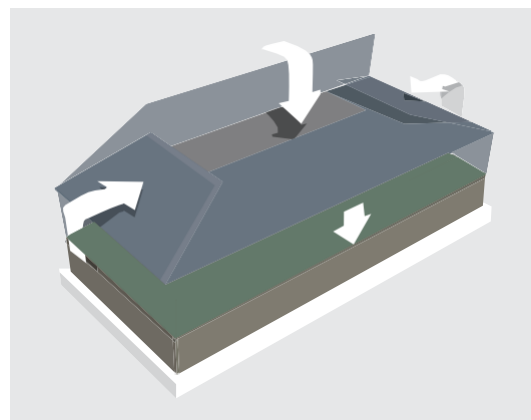
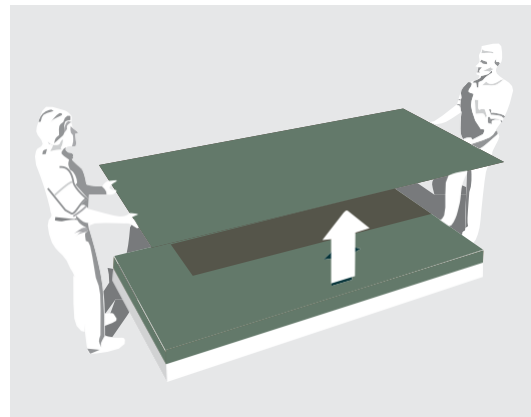

WORKING RECOMMENDATION

4 - MACHINING

Greenlam CLADS can be easily machined with Tungsten carbide-tipped woodworking tools. Cut from Stroke cut and trim Stationary Circular Saws or hand-held circular saws for installation cutting.

All world-renowned producers of hand-held machines like Festo, Bosch, and many others offer guide rails. Tungsten Carbide-tipped Circular saw blades with trapezoidal teeth FZ/TR have produced good results.

To achieve good cutting stroke from Greenlam CLADS following are the recommendations.

S. No	Particulars	Units	Typical Values
1	Circular Saw Dimensions: - Diameter - Material - Thickness - Speed of the saw - Teeth	mm mm rpm nos.	300-400 Tungsten Carbide, Polycrystalline Diamond etc. 3.0 - 4.0 2500 – 6000 72 - 96
2	Scouring saw		Recommended
3	Pressurized holding beam		Mandatory to prevent vibration of the board
4	Cutting speed	meters/minute	8 to 16

Note: The higher the saw blade, the better the top cut and the worse the bottom cut; and vice versa.

Sharp saws and the optimum setting of the saw blade projection are necessary in order to achieve clean cut edges. For fitting work and chamfering on the construction site, electrical hand planes with a chamfering or a mitering groove have proven effective. Use HSS twist drills for manual drilling. Drill tip $\leq 90^\circ$. When using carbide-tipped drills, use pillar drilling machines - carbide metal tends to break off when drilling by hand. Drill against an appropriate base applying enough pressure to ensure a clean exit hole.

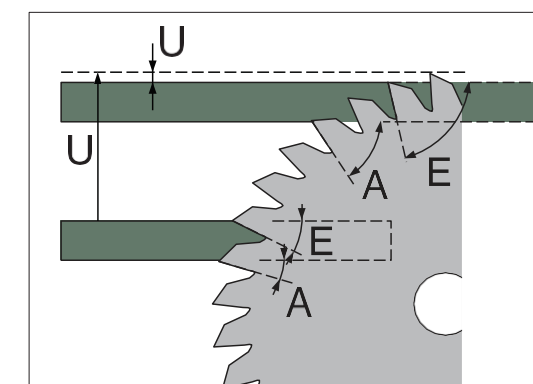

If the projection 'U' becomes greater, the top cut edge gets better and bottom cut edge worse, and vice versa. E = Entry angle; A = Exit angle

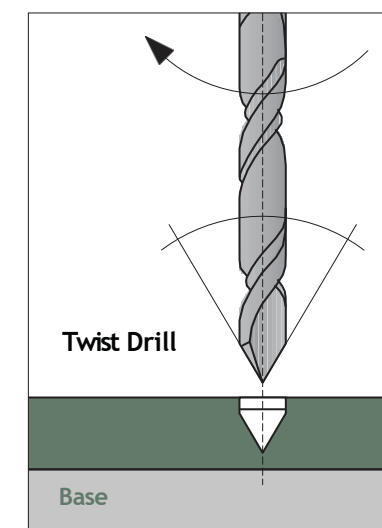

WORKING RECOMMENDATION

Profile Cutting and Edge Finishing

- a. It is not necessary to apply edging strips or edge sealants to Greenlam CLADS panels, and for many applications clean sawn edges are sufficient.
- b. To achieve a superior finish or a profiled edge, use a spindle moulder or router. For this type of work, PCD tooling is recommended. It is not possible completely to avoid cutter marks, but they can be minimised by feeding the work at a constant controlled speed with a mechanical power feed.
- c. Take care to avoid pausing during cutting and profiling, as it may result in burn marks which are difficult to remove. Where edges must be completely free from cutter marks, carry out a further sanding and scraping operation.
- d. Radius should be limited at the transition to the face in order to minimise the “feathering” of the decorative surface.
- e. Buffing with steel wool and applying silicone free oil enhances edges. Chamfering or profiling the edges of Greenlam CLADS panels reduce the risk of edge impact damage.

Drilling

- a. The most suitable drills for use on Greenlam CLADS laminates are those designed for plastic sheet materials. These drills have a point angle of 60° - 80° instead of the normal 120° for drilling metal.
- b. To avoid break-out on the reverse side, gradually reduce the feed speed of the drilling head and the pressure applied when approaching the point of breakthrough.
- c. Working on a firm underlay, such as plywood or chipboard, also reduces the risk of break-out.

Gluing or Jointing: Following techniques are used for jointing or gluing. Gluing application calls for appropriate selection of glue and it is recommended that the user consults the glue supplier for the right type of glue.

- a. Lock Shouldering
- b. Butt Jointing
- c. Lap Jointing

WORKING RECOMMENDATION

Routing and Milling

- a. Routing/Milling can be performed by
 - i) Hand routers and ii) Automated CNC machines.
- b. Hand Routing - finished edges of Greenlam Compact laminate should be routed/milled for achieving good finishing. Rough cut panels to approximately 1/16” before finish routing. It is recommended to use cutters with larger diameter shanks (1/2”) however, smaller tools may be used with minimal feed rates and trim amounts. Two-flute carbide straight cutting bits work well for trimming double-sided panels.
- c. CNC Routing - the appropriate cutting sequence is largely determined by the type of machining required. For example, large panel sizing may be completely different than cutting out nested parts. In any case, the specific panel's thickness, cutting sequence, and type/condition of the machine will require appropriate adjustments according to the particular process. A good starting point for machining is:
 - i) Spindle speed - 16,000 - 18,000 RPMs and ii) Feed-rate - 200 - 900 in/min

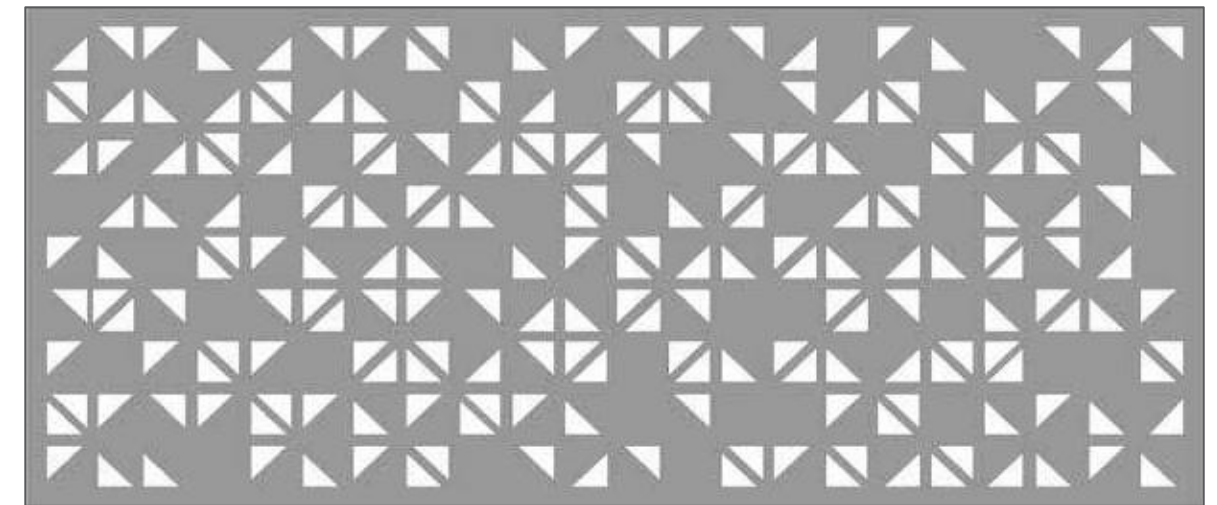

▲
PERFORATED CLAD PANEL

WORKING RECOMMENDATION

5 - PROCESSING

Safety Precautions: The usual best practice applies when operating machinery - appropriate personal protection and hi-vis clothing must be used and tools must be in good condition. The edges of unbeveled panels are sharp, so suitable anti-slip gloves should be worn. Cutting will create dust; protective eyewear and a dust mask are required. Ear defenders must be worn when operating machinery.

Preferred Tools: Good quality tools are required to ensure clean cutting and drilling - diamond tipped drills and sharp, hardened metal blades are recommended. When machining panels, they must be laid on clean, flat, and well-supported surfaces. Chips and particles should be removed to avoid marking the panels.

Tooth Forms

- HZ/FA (Beveled concave tooth) Similar to WZ/FA and HZ/DZ but providing a higher machine longevity.
- TR/TR (Trapezoid tooth/Trapezoid). Best for cutting hard, abrasive laminates.
- FZ/TR (Flat tooth/Trapezoid tooth) Suitable for cutting Greenlam CLADS® panels as well as laminates.
- HZ/DZ (Pendulum tooth/Concave tooth). Useful when cutting on machines where scoring unit is not available.
- WZ/FA (Variable bevelled tooth). This type can be used interchangeably with the Pendulum/Concave tooth.

VARIOUS AREAS OF APPLICATIONS

1: PARAPET INSTALLATION

Greenlam CLADS is highly suited to forming balustrades, from both the aesthetic and safety perspectives. It's an excellent alternative to concrete or glass in these applications as both these materials have low impact strength, less durability, and limited colour options compared to Greenlam CLADS.

Greenlam CLADS panels are also easy to maintain and they keep their good looks for a long time. There are many fixing options available that add greater flexibility to your specification process:

- Fitting to posts using fasteners or clamps
- Fitting to posts - in modules
- Fitting to posts - continuous
- Fitting to posts using profiles Installation is generally performed using bolts, screws, self-drilling connectors or blind rivets affixed to aluminium or steel profiles.

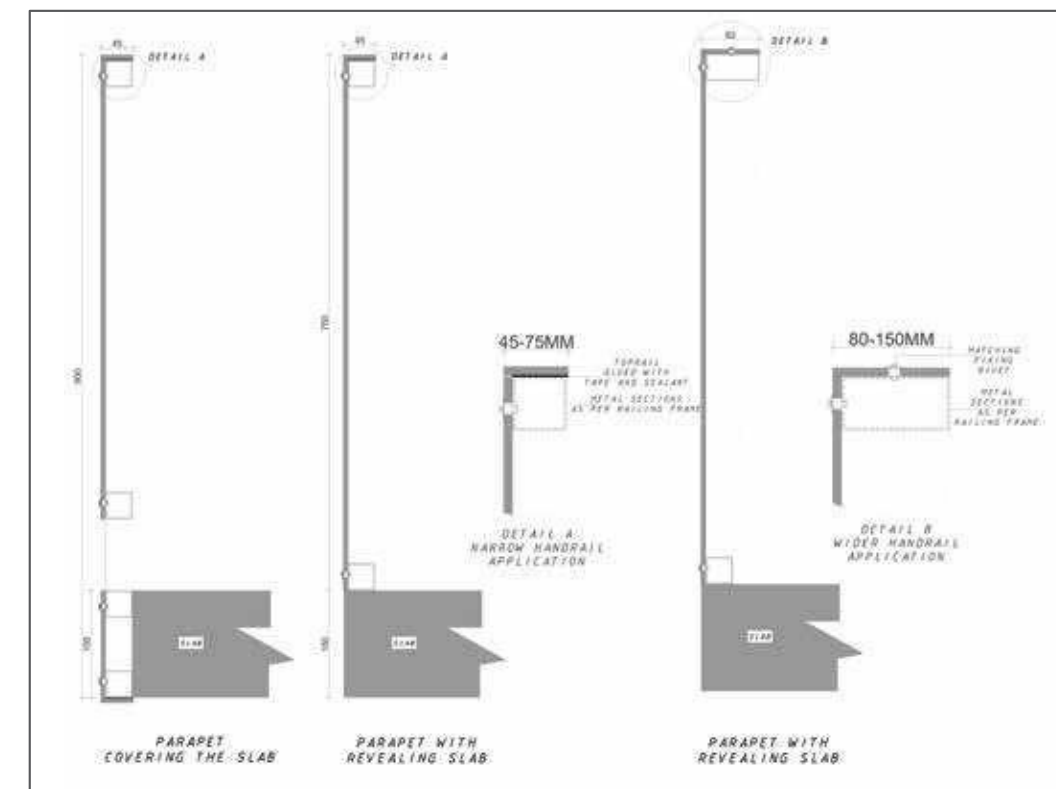

A: PARAPET AND BALUSTRADE

A parapet system incorporating Greenlam CLADS panels should have strength and be sufficiently durable. The height of balcony parapet should conform to local building regulations. Its height should not be less than 100 cm, and for buildings over 12 m, it should be at least 110 cm high.

VARIOUS AREAS OF APPLICATIONS

PARAPET CORNERS

With many corner form options, Greenlam CLADS can fulfil different aesthetic and technical demands.

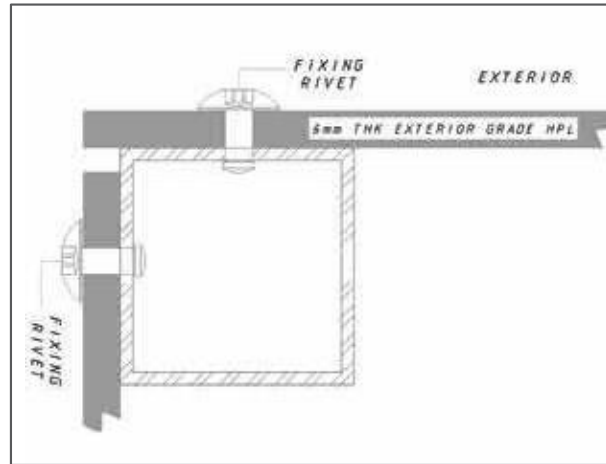

Open Corners: The front panel is positioned over the side panels, revealing the natural color of the board at its vertical edges.

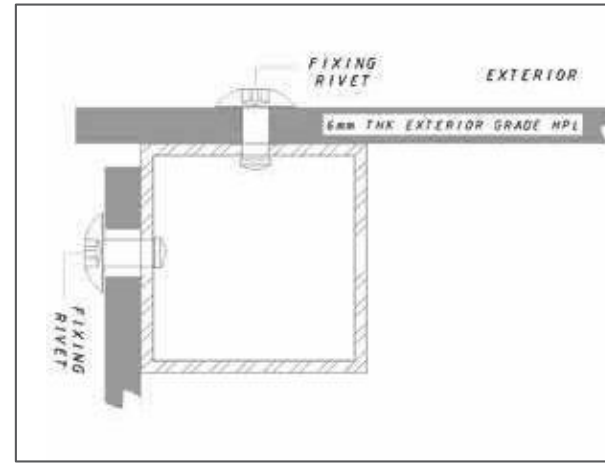

Masking Uneven Substructures: If supports are running out of true, by over-projecting the facing panel by around 10 mm each end it's possible to achieve a neat straight appearance.

VARIOUS AREAS OF APPLICATIONS

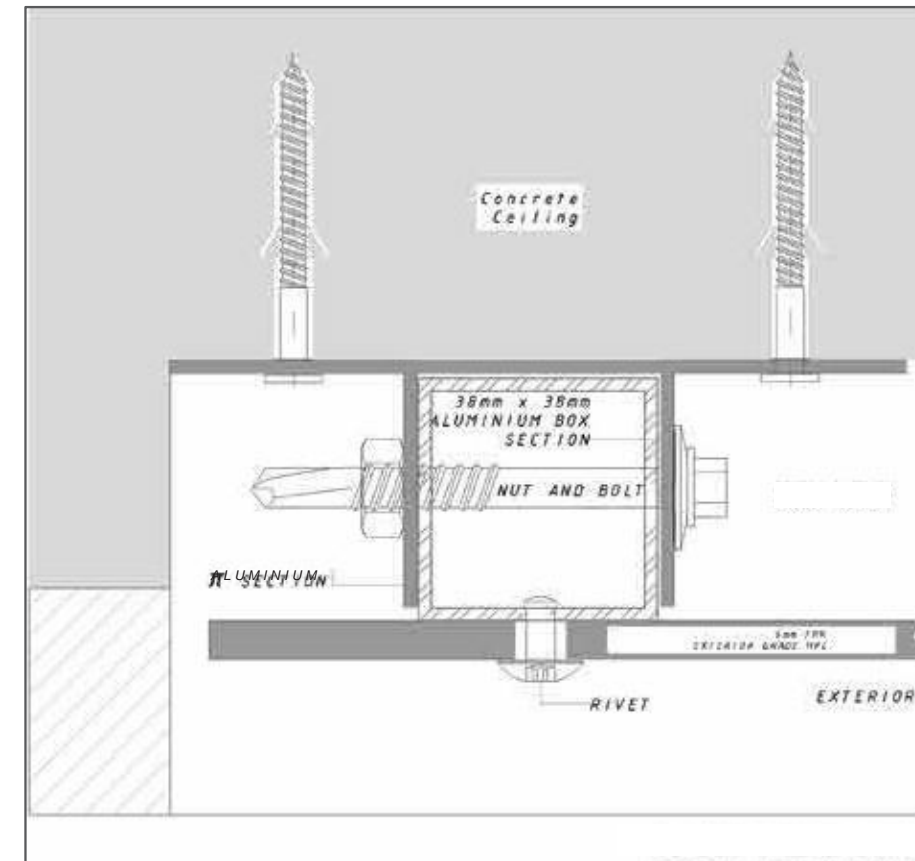

SOFFIT CORNER DETAIL

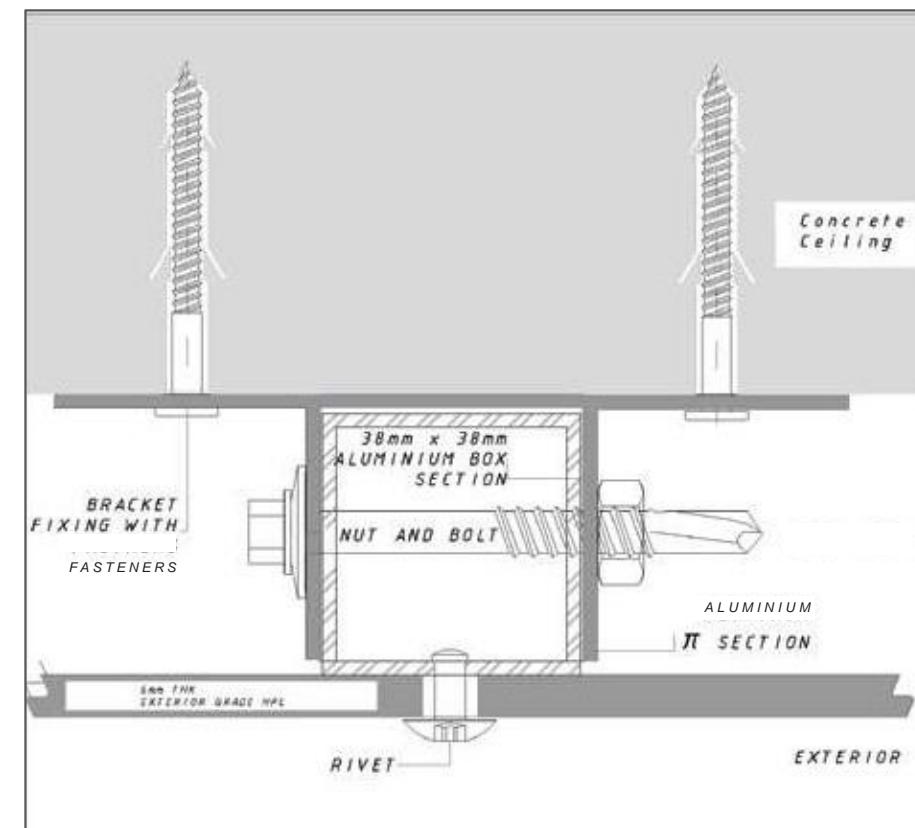

SOFFIT CLADDING DETAIL

2: BALCONY SOFFITS AND SUNSHADE INSTALLATION

Greenlam CLADS is highly suited to forming soffits, sunshades, and pergolas from aesthetic and safety perspectives. It's an excellent alternative to brick or glass in these applications as both these materials have low impact strength, less durability, and limited colour options compared to Greenlam CLADS.

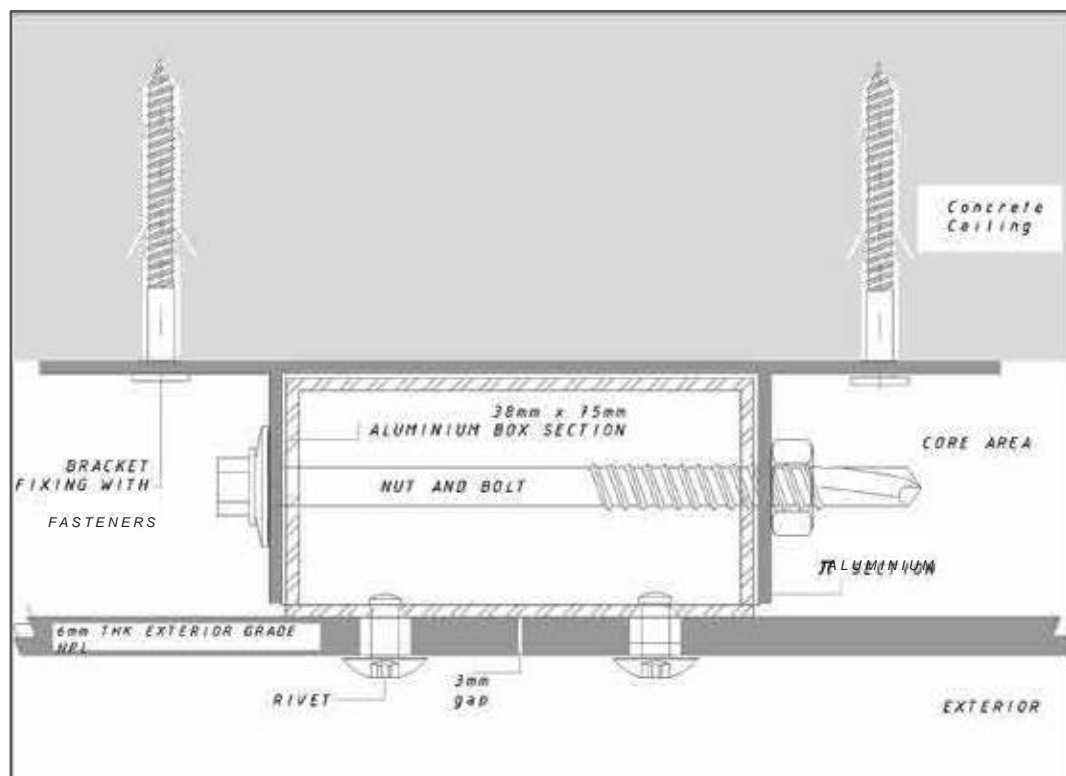

SOFFIT MID JOINT CLADDING DETAIL

STB INNOVATIVE CONSTRUCTION

09-8659011 | info@stboards.com | www.stboards.com

VARIOUS AREAS OF APPLICATIONS

3: SCREENING AND PARTITIONS INSTALLATION

Greenlam CLADS is highly suited to forming screens and works effectively from all perspective - aesthetic, privacy, and safety. It's an excellent alternative to wood, concrete or glass in these applications as these materials have low impact strength, less durability and limited colour options compared to Greenlam CLADS.

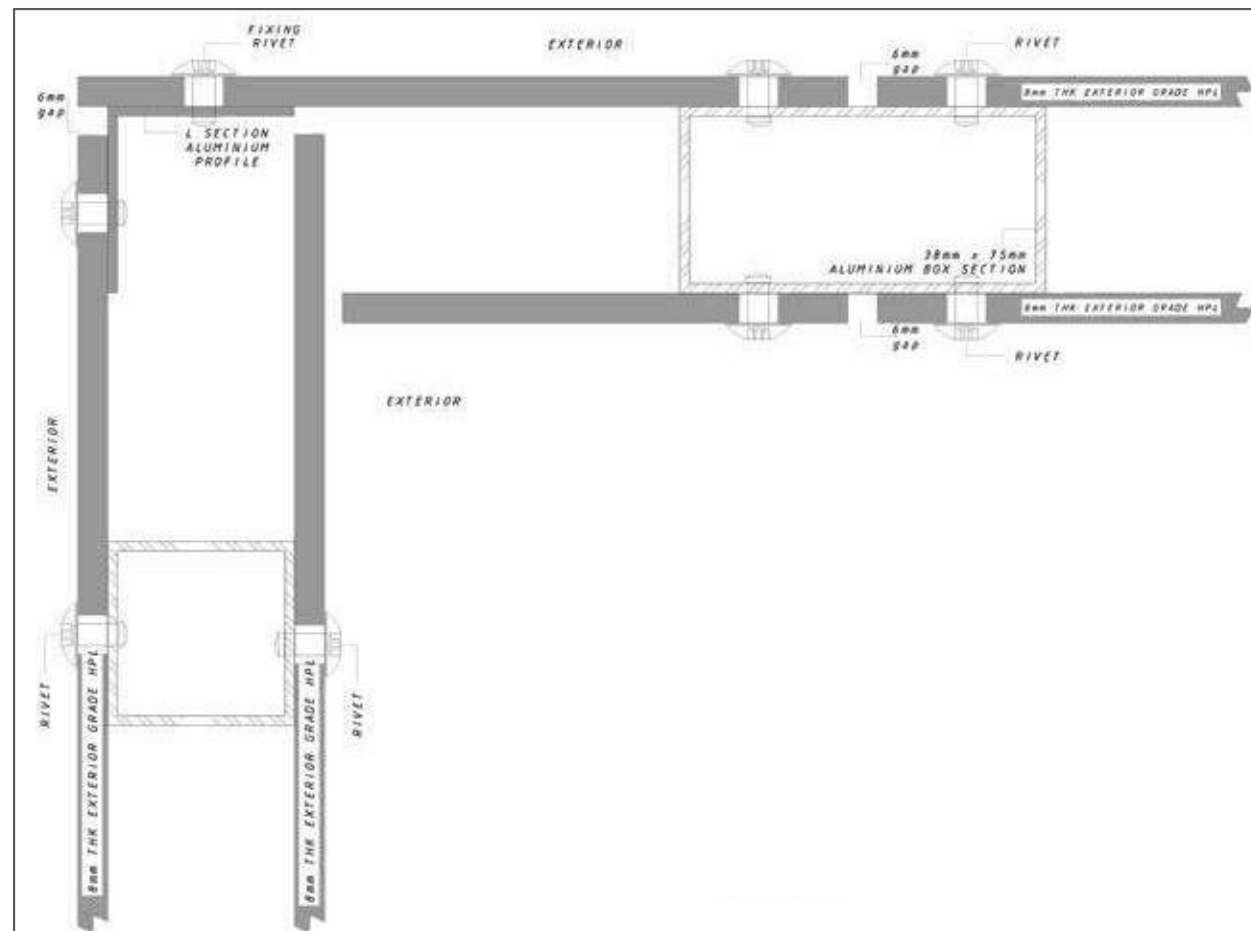

▲ SCREENING PARTITION DETAIL

VARIOUS AREAS OF APPLICATIONS

4: BOUNDARY WALLS AND FENCES INSTALLATION

Greenlam CLADS is highly suited to form boundary wall cladding screens and works effectively from all perspective - aesthetic, privacy, and safety. It's an excellent alternative to wood, concrete or glass in these applications as these materials have low impact strength, less durability and limited colour options compared to Greenlam CLADS.

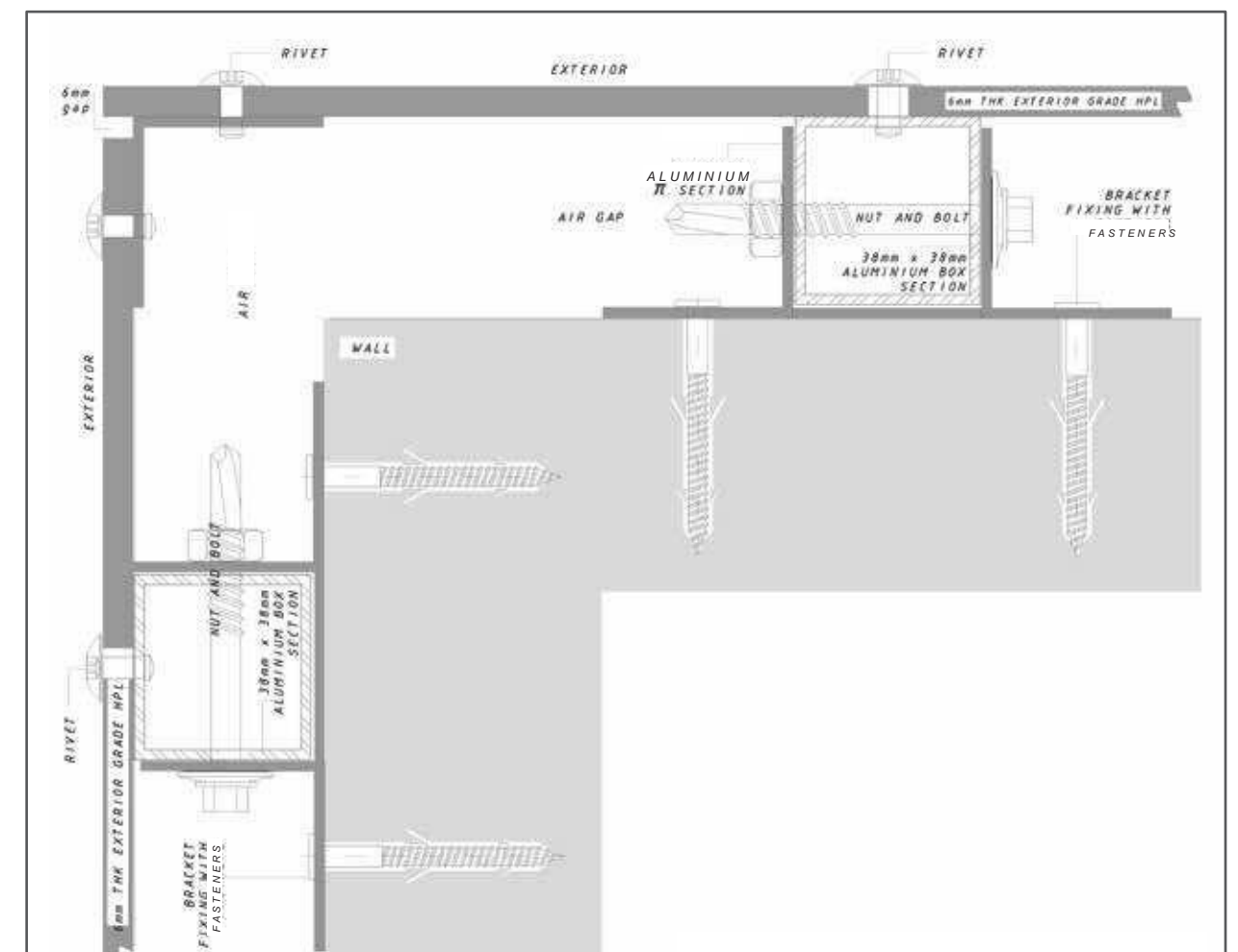

▲ BOUNDARY WALL CLADDING DETAIL

STB INNOVATIVE CONSTRUCTION

09-8659011 | info@stboards.com | www.stboards.com

TECHNICAL SPECIFICATIONS

Product: Greenlam Exterior Clads 1.30m x 3.05m

Properties	Unit	Test Method as per EN 438 Part 2 : 2016	Specified Values as per EN 438 Part 6: 2016	Greenlam Clads' Results
Physical & Dimensional Properties				
Classification	EN 438-6- 4	Exterior Severe Use Flame Retardant Grade, Edf		
Surface Quality (Dirt, Spots etc.)	mm ² /M ²	EN 438-6, 5.2.4	2.0 (max)	Complies
Fibers, Hairs & Scratches etc.,	mm/M ²		20.0 (max)	Complies
Thickness & Maximum Variation	mm	EN 438-2 – 5	2,0 ≤ t < 3,0 : ± 0,20 3,0 ≤ t < 5,0: ± 0,30 5,0 ≤ t < 8,0 : ± 0,40 8,0 ≤ t < 12,0: ± 0,50 12,0 ≤ t < 16,0: ± 0,60 16,0 ≤ t < 20,0: ± 0,70 20,0 ≤ t < 25,0: ± 0,80 25,0 ≤ t: As agreed	Complies
Length & Width	mm	EN 438-2 – 6	+10mm / -0mm	+5mm / -0mm
Flatness	mm/M	EN 438-2 – 9	2,0 ≤ t < 6,0 : 8.0 6,0 ≤ t < 10,0 : 5.0 10,0 ≤ t : 3.0	Complies
Edges Straightness	mm/M	EN 438-2 – 7	1.5 (max)	≤ 1
Edges Squareness	mm/M	EN 438-2 – 8	1.5 (max)	Complies
Density	g/cm ³	EN ISO 1183-1 :2004	1.35	1.38
Dimensional Stability at Elevated Temperature		EN 438-2 – 17		
a) Longitudinal	%		0.30(max.)	0.18
b) Transverse	%		0.60 (max)	0.38

Mechanical Properties				
Resistance to Wet Conditions,	EN 438-2 : 15			
Increase in Mass		%	8.0 (max)	4.1
Surface Rating		Rating	4 (min)	5
Edge Rating		Rating	3 (min)	3
Resistance to Impact by Large Diameter Ball				
Drop Height	EN 438-2 -22	mm	1800	2000
Diameter of Indentation		mm	10 (max)	7
Flexural Strength	EN ISO 178:2003	Mpa	80 (min)	100
Flexural Modulus	EN ISO 178:2003	Mpa	9000(min)	10700
Thermal Conductivity	EN 12524:2000	W/M ² K	No Requirement	0.24
Resistance to Fixing (Screw Pull Out Strength)	ISO 13894-1; 9	N	2000 (min)	Meets

Light Fastness & Weather Resistance				
Resistance to Climatic Shock				
a) Flexural Strength Index				
b) Flexural Modulus Index	EN 438-2 : 19	Rating	Appearance -4 (min)	4
		Rating	Ds – 0.80 (min)	Meets
		Rating	Dm – 0.80 (min)	Meets
Resistance to Artificial Weathering Including Light Fastness, After 650 MJ/M ² Radiant Exposure, (for Over 3500 Hours of Exposure)	EN 438-2-29	Rating (after 3000 Hours as per Standard)	Grey Scale contrast-3 (min) Appearance- 4 (min.)	3~4 4~5
Resistance to UV Light, after 1500 Hours Exposure	EN 438-2-28	Rating	Grey Scale Contrast-3 (min) Appearance- 4 (min.)	3~4 4~5

Properties	Unit	Test Method	Specified Values	Greenlam Clads Results
Fire Performance				
Reaction to Fire	EN 13501-1-2017	Euro Class	≥ 6.0mm -B-s2, d0	B-s1, d0
Surface spread of flame	UL 723	Class	A	A
Flame Spread Index		Index	0-25	Meets
Smoke Development Index		Index	0 - 450	Meets
Calorific Value	ISO 1716: 2010	MJ/ Kg	19.91 (max)	Meets

Health Characteristics				
Anti-bacterial Efficacy & Activity	JIS 2801-2012			
%Reduction in 24 hours		%	95.0 (min)	99.99
Activity After 24 hours		Log Reduction	2.0 (min)	Exceeds
Anti-Fungus Efficacy	ASTM G21-2015			
Growth After 28 days		Class	1	0 (No Growth)

Corrosion Resistance				
Resistance to Corrosion with 5% Sodium Chloride Spary	ASTM B 117	Hours	500 Minimum (Industry standard)	Exceeds 700
Resistance to acid rains (of 10% HCl)	In House	Hours	None	24

Properties	Unit	Test Method	Specified Values	Greenlam Clads Results
Sound Insulation Characteristics In Building & Building Elements				
Sound Transmission Class (STC)	IS: 9901 (Part III)-1981, DIN: 52210 Part 1-1983 ISO: 10140 (Part II)/ ASTM – E- 90	Class	No Specification	28

Class (Rating) : 1 = Surface Damage 2 = Severe appearance alteration 3 = Moderate Change 4 = Slight change visible from certain angle 5 = No Change

Bacteria Tested: 1. Pseudomonas Aeruginosa, 2. Enterococcus Faecalis, 3. Candida Albicans, 4. Pseudomonas Aeruginosa, 5. Escherichia Coli, 6. Klebsiella Pneumoniae, 7. MRSA (Methicillin Resistant Staphylococcus Aureus), 8. Salmonella Enterica

Fungus Tested: 1.Aspergillus niger, 2. Penicillium funiculosum, 3. Gliocladium virens, 4. Chaetobium globosum 5. Aurobasidium pullulans

Note: Greenlam products are manufactured thoroughly to standards. The values given above are to the best of knowledge but without liability/warranty, expressed or implied.

W A r r A n t y D E t A i L s

Clads promising you 12 years of Warranty.

Salient Features

- CHEMICAL RESISTANT
- ANTI GRAFFITI PROPERTY
- FIRE RETARDANT
- EXCLUSIVE RANGE
- COMPLEMENTING HARDWARE (RIVETS)
- LIGHT FASTNESS PROPERTY
- ENVIRONMENT FRIENDLY GREEN DNA

Storage

Storage of the panels on site should be horizontally on a -at wooden pallet under shade

Installation

Guidelines Box section size –

- 38mmx38mmx2mm, and
- 38mmx75mmx2mm (for area where two panels are joining)

M. S. Brackets - Wind Load and Dead Load Brackets

Rivets - Greenlam Standards Rivets

Nut and Bolts - S. S.

Framing Distance - Maximum 600mm for façade and 450mm for sot

Rivet Distance - Have to maintain a distance of 450mm to 600mm

Gap between panels - Minimum 6mm (horizontally & vertically both)

Fasteners - Standard Fasteners as per requirement

WARRANTY FOR GREENLAM CLADS

Greenlam provides a warranty for the Exterior Grade Compacts (“Product”) for a period of 12 years

(“Warranty Period”) subject to the following terms and conditions

W A r r A n t y D E t A i L s

Limitation

The limitation of the warranty being given herein is the sole warranty for the following purposes, excluding all other warranties, whether expressed or implied:

- a. The Product shall meet the applicable manufacturing standards.
- b. The Product shall not delaminate for the Warranty Period specially meaning that there shall be no separation between the plies and their bonds.
- c. The colour and/or shine of the exterior surface of the Product may fade or lighten by exposure to normal weather conditions of sun, rain and dust within permissible limit as per international standard during the Warranty Period.

The aforesaid warranties are subject to the condition that the Product is installed in the external surface of a building in India, strictly as per the instructions for installation as provided with the Product.

“Installation manual is for guidance purpose only”.